



## Double Insulated Position Switches IN62, IN65 and I81

# Double Insulated Position Switch IN62

- Position Switch in accordance with EN 50047
- Only available with plunger actuator

## Advantages

- High reliability at low currents (1 mA)
- Protection class IP 67
- Hinged snap-on cover

## Technical Data

- Mechanical service life:  
30 million switching cycles
- Electrical service life:  
1 million switching cycles
- Contact safety: 1 mA for 5 V DC



## Order data IN62 as complete system

The switches have standard fixings and an M20 cable entry.

IN62-... SK	Designation	Article number	System	Switching function
	IN62-SU1Z SK	6083000200	Snap action	1 NC / 1 NO
	IN62-U1Z SK	6083000201	Slow action	1 NC / 1 NO
	IN62-SA2Z SK	6083000202	Snap action	2 NC
	IN62-A2Z SK	6083000203	Slow action	2 NC
	IN62-SE2 SK	6083000204	Snap action	2 NO
	IN62-E2 SK	6083000205	Slow action	2 NO
	IN62-UV1Z SK	6083000206	Slow action	1 NC / 1 NO overlapping



# Double Insulated Position Switch IN65

- Position Switch in accordance with EN 50047
- Modular design
- Easy modular adjustment of actuator head through 45° increments



## Advantages

- High reliability at low currents (1 mA)
- Tool-free rotation and changing of actuator
- Actuator made of metal
- Protection class IP 66/67
- Hinged snap-on cover

## Technical Data

- Mechanical service life: 30 million switching cycles
- Electrical service life: 1 million switching cycles
- Contact safety: 1 mA for 5 V DC

### Adjustable actuator elements

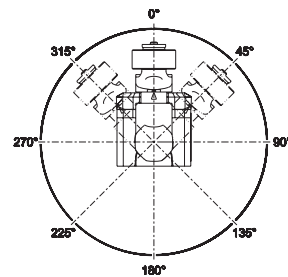

### Rotatable lever

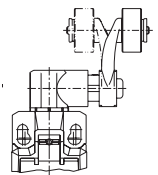

### Adjustable lever

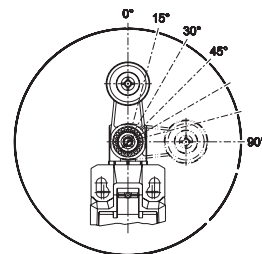

## Rotate actuator

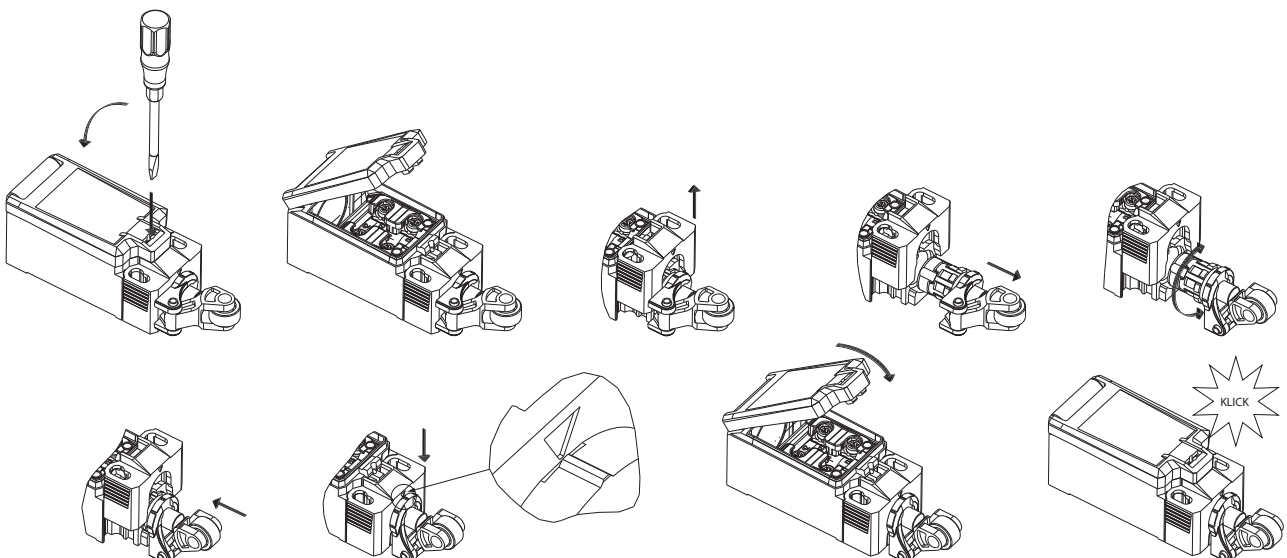

# Double Insulated Position Switch I81

- Integrated latch function: After actuation manually reset by pulling the blue button necessary
- Modular design
- Easy modular adjustment of actuator head through 45° increments

## Advantages

- High reliability at low currents (1 mA)
- Tool-free rotation and changing of actuator
- Actuator made of metal
- Protection class IP 66/67
- Hinged snap-on cover

## Technical Data

- Mechanical service life: 30 million switching cycles
- Electrical service life: 1 million switching cycles
- Contact safety: 1 mA for 5 V DC



Adjustable actuator elements

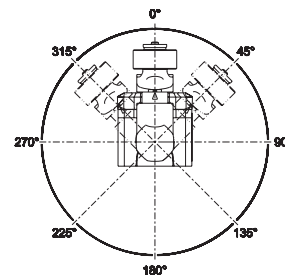

Rotatable lever

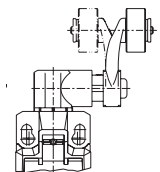

Adjustable lever

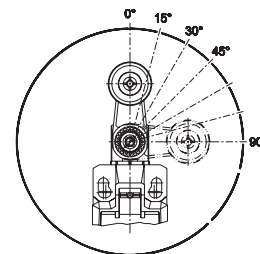

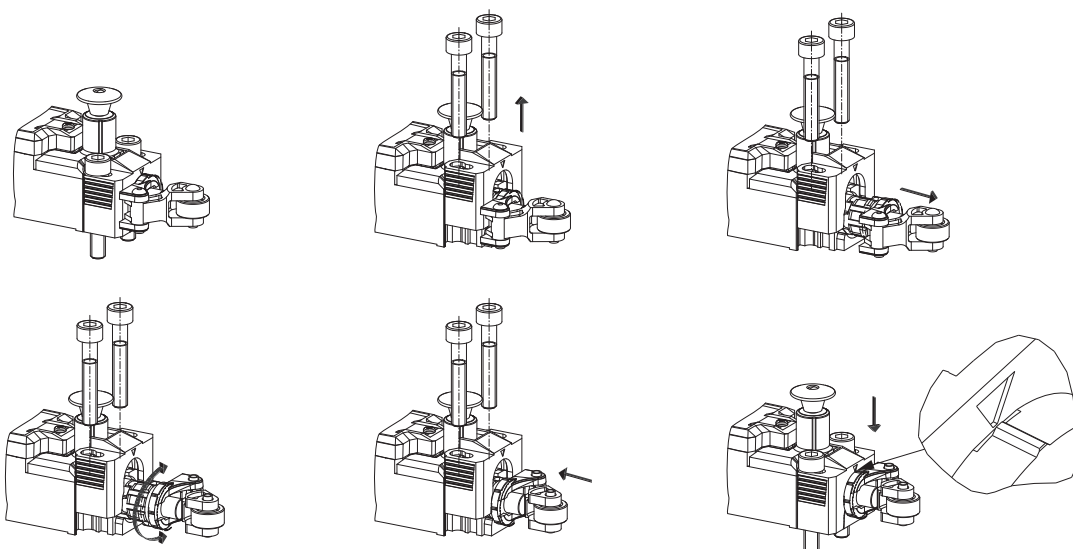

## Rotate actuator





# Order data IN65 as complete assembly

The switches have standard fixings and an M20 cable entry.

IN65-... SM	Designation	Article number	System	Switching function
	IN65-SU1Z SM	6083000207	Snap action	1 NC / 1 NO
	IN65-U1Z SM	6083000208	Slow action	1 NC / 1 NO
	IN65-SA2Z SM	6083000209	Snap action	2 NC
	IN65-A2Z SM	6083000210	Slow action	2 NC
	IN65-SE2 SM	6083000211	Snap action	2 NO
	IN65-E2 SM	6083000212	Slow action	2 NO
	IN65-UV1Z SM	6083000213	Slow action	1 NC / 1 NO overlapping

IN65-... RK	Designation	Article number	System	Switching function
	IN65-SU1Z RK	6083000214	Snap action	1 NC / 1 NO
	IN65-U1Z RK	6083000215	Slow action	1 NC / 1 NO
	IN65-SA2Z RK	6083000216	Snap action	2 NC
	IN65-A2Z RK	6083000217	Slow action	2 NC
	IN65-SE2 RK	6083000218	Snap action	2 NO
	IN65-E2 RK	6083000219	Slow action	2 NO
	IN65-UV1Z RK	6083000220	Slow action	1 NC / 1 NO overlapping

IN65-... HK	Designation	Article number	System	Switching function
	IN65-SU1Z HK	6083000221	Snap action	1 NC / 1 NO
	IN65-U1Z HK	6083000222	Slow action	1 NC / 1 NO
	IN65-SA2Z HK	6083000223	Snap action	2 NC
	IN65-A2Z HK	6083000224	Slow action	2 NC
	IN65-SE2 HK	6083000225	Snap action	2 NO
	IN65-E2 HK	6083000226	Slow action	2 NO
	IN65-UV1Z HK	6083000227	Slow action	1 NC / 1 NO overlapping

IN65-... DGHK	Designation	Article number	System	Switching function
	IN65-SU1Z DGHK	6083000228	Snap action	1 NC / 1 NO
	IN65-U1Z DGHK	6083000229	Slow action	1 NC / 1 NO
	IN65-SA2Z DGHK	6083000230	Snap action	2 NC
	IN65-A2Z DGHK	6083000231	Slow action	2 NC
	IN65-SE2 DGHK	6083000232	Snap action	2 NO
	IN65-E2 DGHK	6083000233	Slow action	2 NO
	IN65-UV1Z DGHK	6083000234	Slow action	1 NC / 1 NO overlapping

# Order data IN65/I81 as complete assembly

The switches have standard fixings and an M20 cable entry.

IN65-... DGKK	Designation	Article number	System	Switching function
	IN65-SU1Z DGKK	6083000254	Snap action	1 NC / 1 NO
	IN65-U1Z DGKK	6083000255	Slow action	1 NC / 1 NO
	IN65-SA2Z DGKK	6083000256	Snap action	2 NC
	IN65-A2Z DGKK	6083000257	Slow action	2 NC
	IN65-SE2 DGKK	6083000258	Snap action	2 NO
	IN65-E2 DGKK	6083000259	Slow action	2 NO
	IN65-UV1Z DGKK	6083000260	Slow action	1 NC / 1 NO overlapping

IN65-... KNK	Designation	Article number	System	Switching function
	IN65-SU1Z KNK	6083000261	Snap action	1 NC / 1 NO
	IN65-U1Z KNK	6083000262	Slow action	1 NC / 1 NO
	IN65-SA2Z KNK	6083000263	Snap action	2 NC
	IN65-A2Z KNK	6083000264	Slow action	2 NC
	IN65-SE2 KNK	6083000265	Snap action	2 NO
	IN65-E2 KNK	6083000266	Slow action	2 NO
	IN65-UV1Z KNK	6083000267	Slow action	1 NC / 1 NO overlapping

IN65-... AHK	Designation	Article number	System	Switching function
	IN65-SU1Z AHK	6083000235	Snap action	1 NC / 1 NO
	IN65-U1Z AHK	6083000236	Slow action	1 NC / 1 NO
	IN65-SA2Z AHK	6083000237	Snap action	2 NC
	IN65-A2Z AHK	6083000238	Slow action	2 NC
	IN65-SE2 AHK	6083000239	Snap action	2 NO
	IN65-E2 AHK	6083000240	Slow action	2 NO
	IN65-UV1Z AHK	6083000241	Slow action	1 NC / 1 NO overlapping

I81-...	Designation	Article number	System	Switching function
	I81-U1Z SM	6083000242	Slow action	1 NC / 1 NO
	I81-U1Z RK	6083000243	Slow action	1 NC / 1 NO
	I81-U1Z HK	6083000244	Slow action	1 NC / 1 NO
	I81-U1Z DGHK	6083000245	Slow action	1 NC / 1 NO
	I81-U1Z DGKK	6083000268	Slow action	1 NC / 1 NO
	I81-U1Z KNK	6083000269	Slow action	1 NC / 1 NO
	I81-U1Z AHK	6083000246	Slow action	1 NC / 1 NO

# Order data IN65 / I81 as component parts

## Actuators

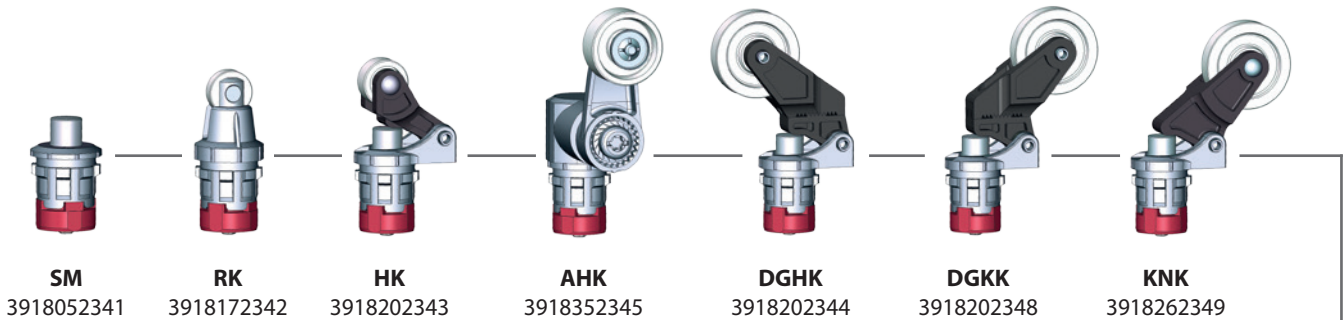

Designation	Article number	System	Switching function
C14-EB-U1Z	6005101156	Slow action	Changeover switch
C14-EB-SU1Z	6005151157	Snap action	Changeover switch
C14-EB-UV1Z	6005301158	Slow action	Changeover switch with overlapping
C14-EB-A2Z	6005801159	Slow action	2 NC
C14-EB-SA2Z	6005851160	Snap action	2 NC
C14-EB-SE2	6005851161	Snap action	2 NO
C14-EB-E2	6005801162	Slow action	2 NO

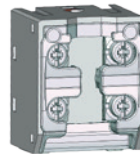

**Switching unit**

## Empty housing

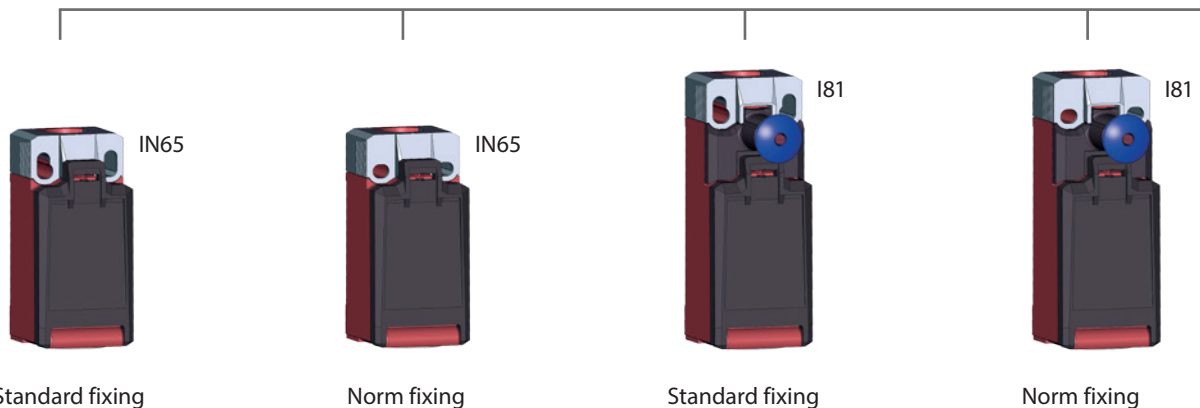

Cable outlet	Article no.	Cable outlet	Article no.	Cable outlet	Article no.	Cable outlet	Article no.
M16	6083000247	M16	6083000249	M16	6083000251	M16	6083000253
M20	6083000248	M20	6083000250	M20	6083000252	M20	6083000270

Housings also available in black





**Switch systems –  
Economy meets safety**



**Sensor systems –  
Compact intelligence**



**Enclosure systems –  
Function and design**

[www.bernstein.eu](http://www.bernstein.eu)

## Contact

**International Headquarters  
BERNSTEIN AG**  
Hans-Bernstein-Str. 1  
32457 Porta Westfalica  
Phone +49 571 793-0  
Fax +49 571 793-555  
info@de.bernstein.eu  
www.bernstein.eu

**Denmark  
BERNSTEIN A/S**  
Phone +45 7020 0522  
Fax +45 7020 0177  
info@dk.bernstein.eu

**France  
BERNSTEIN S.A.R.L.**  
Phone +33 1 64 66 32 50  
Fax +33 1 64 66 10 02  
info@fr.bernstein.eu

**Italy  
BERNSTEIN S.r.l.**  
Phone +39 035 4549037  
Fax +39 035 4549647  
info@it.bernstein.eu

**United Kingdom  
BERNSTEIN Ltd**  
Phone +44 1922 744999  
Fax +44 1922 457555  
info@uk.bernstein.eu

**Austria  
BERNSTEIN GmbH**  
Phone +43 2256 62070-0  
Fax +43 2256 62618  
info@at.bernstein.eu

**Switzerland  
BERNSTEIN (Schweiz) AG**  
Phone +41 44 775 71-71  
Fax +41 44 775 71-72  
info@ch.bernstein.eu

**Hungary  
BERNSTEIN Kft.**  
Phone +36 1 4342295  
Fax +36 1 4342299  
info@hu.bernstein.eu

**China  
BERNSTEIN Safe Solutions  
(Taicang) Co., Ltd.**  
Phone +86 512 81608180  
Fax +86 512 81608181  
info@bernstein-safesolutions.cn