



BERNSTEIN
Contactless safety technology

Product overview

The use of contact-free locking facilities, in particular for monitoring movable safety guards, offers the following advantages:

- Simple adjustment
- No broken actuator
- High degree of tolerance to vibrations, moved doors and hoods
- No wear
- Exceptionally easy cleaning

BERNSTEIN offers two different technologies in the area of contactless safety technology:

- Safety sensors on magnetic basis (**MAK series**)
- Safety sensors on RFID basis (**CSMS series**)

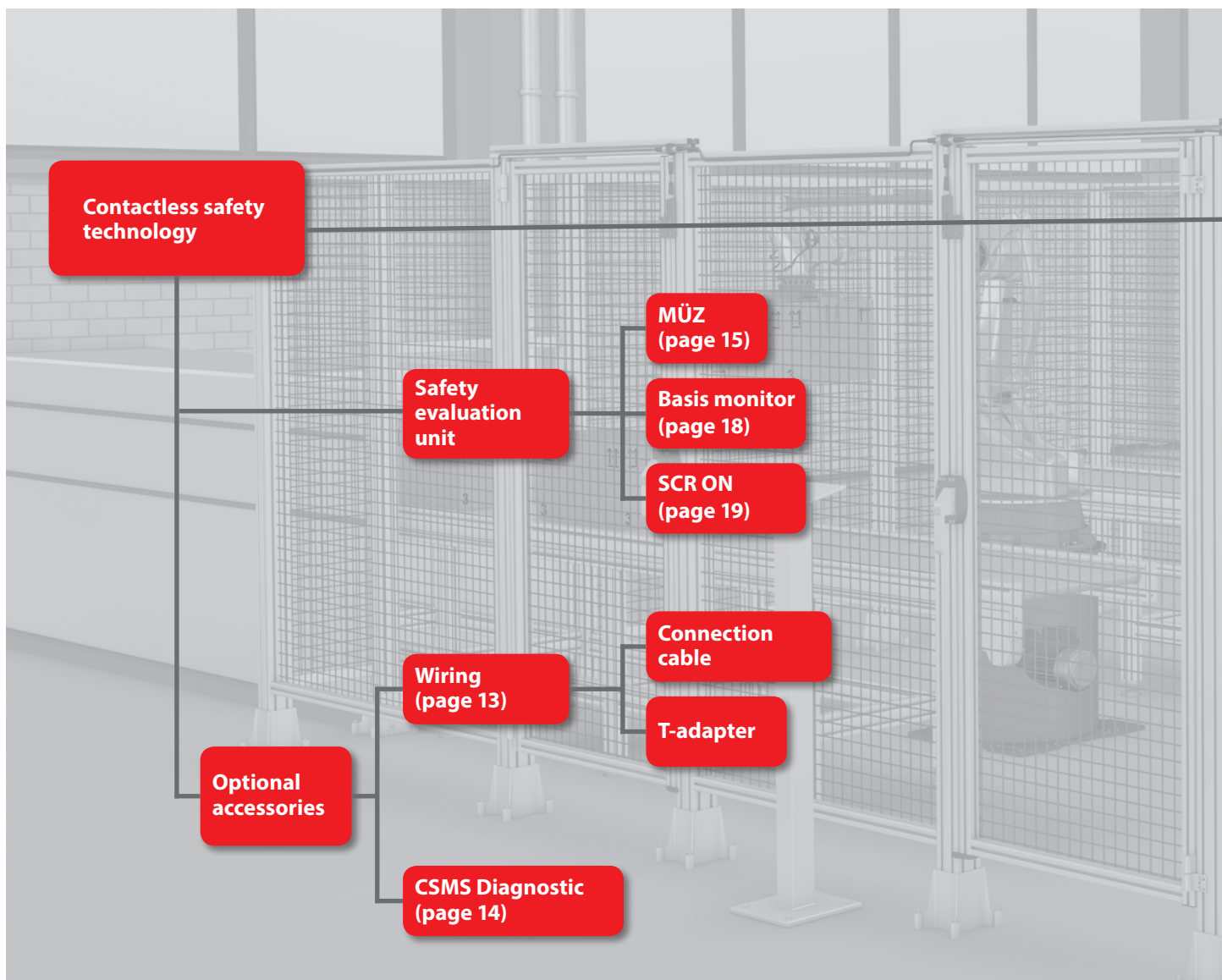

Comparison CSMS (RFID) – MAK (Magnetic)

Product characteristics	CSMS	MAK
Operating principle	RFID	magnetic
Safety parameters	up to PL e, SIL 3	up to PL d, SIL 3
Safety outputs	electrical outputs	mechanical contacts
Serial connection	yes, when a constant safety level is guaranteed	yes, with falling safety level
Evaluation unit required	no	yes
Actuator coding (according to ISO 14119)	high (unicode) or low (multicode)	low (multicode)
Sensing distance	13 mm	3–4 mm
Diagnostic interface	via LED and electronically	no
Mechanical sensitivity	low	very high
Approach possibility of the actuator	4	1
Safety outputs	2	1
Return circuit evaluation	yes, when using CSMS-RRS	partially (depending on the evaluation unit)
Start button monitoring	yes, when using CSMS-RRS	partially (depending on the evaluation unit)

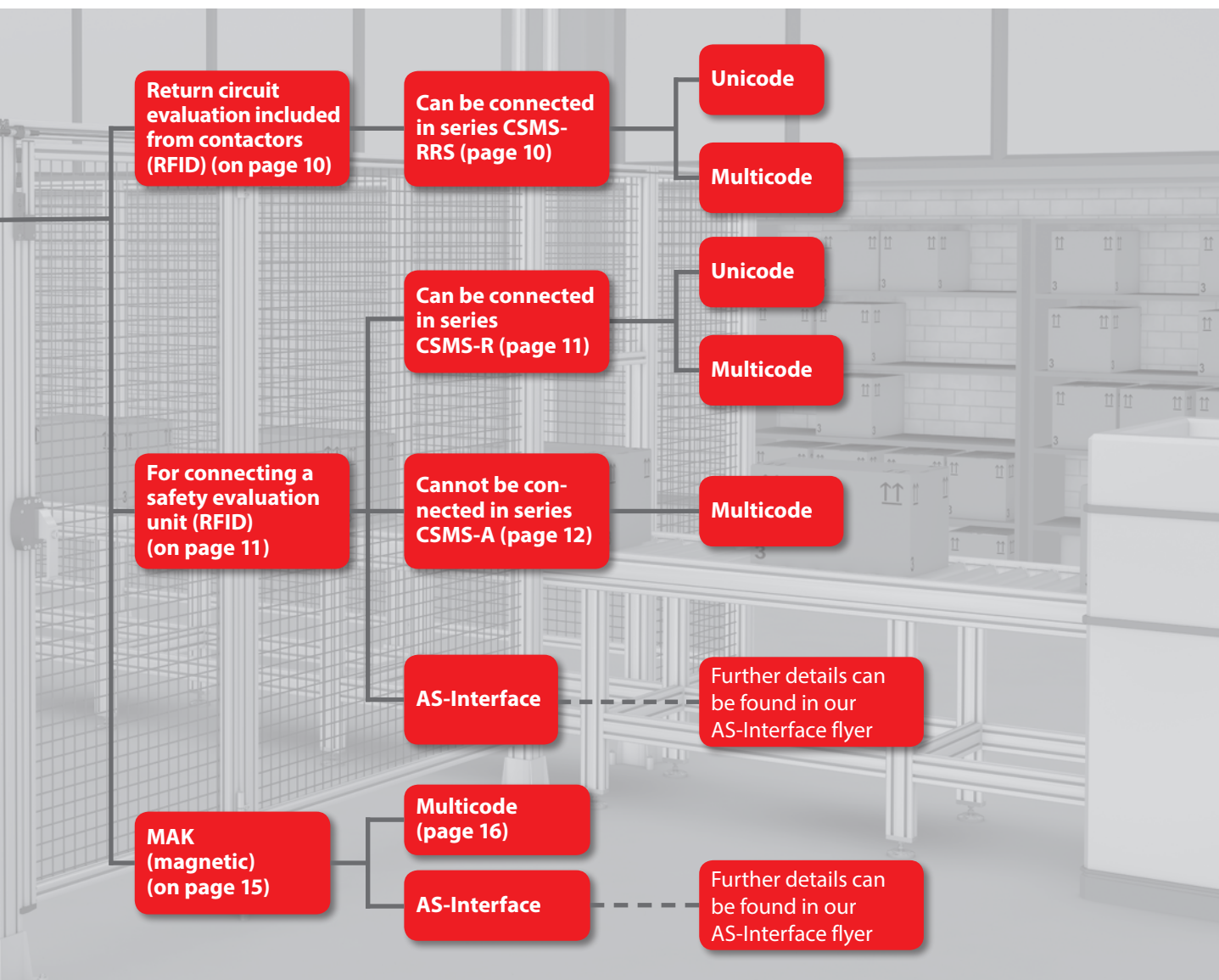

The CSMS

Contactless Safety Monitoring Sensor

The CSMS is an electronical safety sensor that ensures that safety doors and protective guards remain closed. In addition to high switching tolerances, the contactless, coded communication between the sensor and the actuator also offers a high level of safety and protection against manipulation.



According to **ISO 14119**, interlocking devices are mechanical or electrical devices which are designed to prevent the operation of a machine element for as long as the movable safety guard is left open.

The CSMS based on RFID is contactless and fulfils the highest requirement (high-level coding) of protection against manipulation of **ISO 14119**.

The BERNSTEIN CSMS offers both a high-level coding and a low-level coding, in order to provide the optimum protection against manipulation for each application.

The safety-related capacity of the CSMS is demonstrated through full observation of the following standards:

- Requirements for safety-related parts of control systems up to **PL e in accordance with ISO 13849-1**
- Functional safety up to **SIL 3 in accordance with IEC 62061**
- Choice and use of safety-related interlocking devices of **type 4 in accordance with ISO 14119**

unicode/high coding:

Sensor accepts only one actuator

multicode/low coding:

Sensor accepts several actuators

Use and application

The CSMS is used for monitoring movable safety guards. When the protective device is opened, a signal is generated by the CSMS that stops the machine and prevents a dangerous restart of the machine.

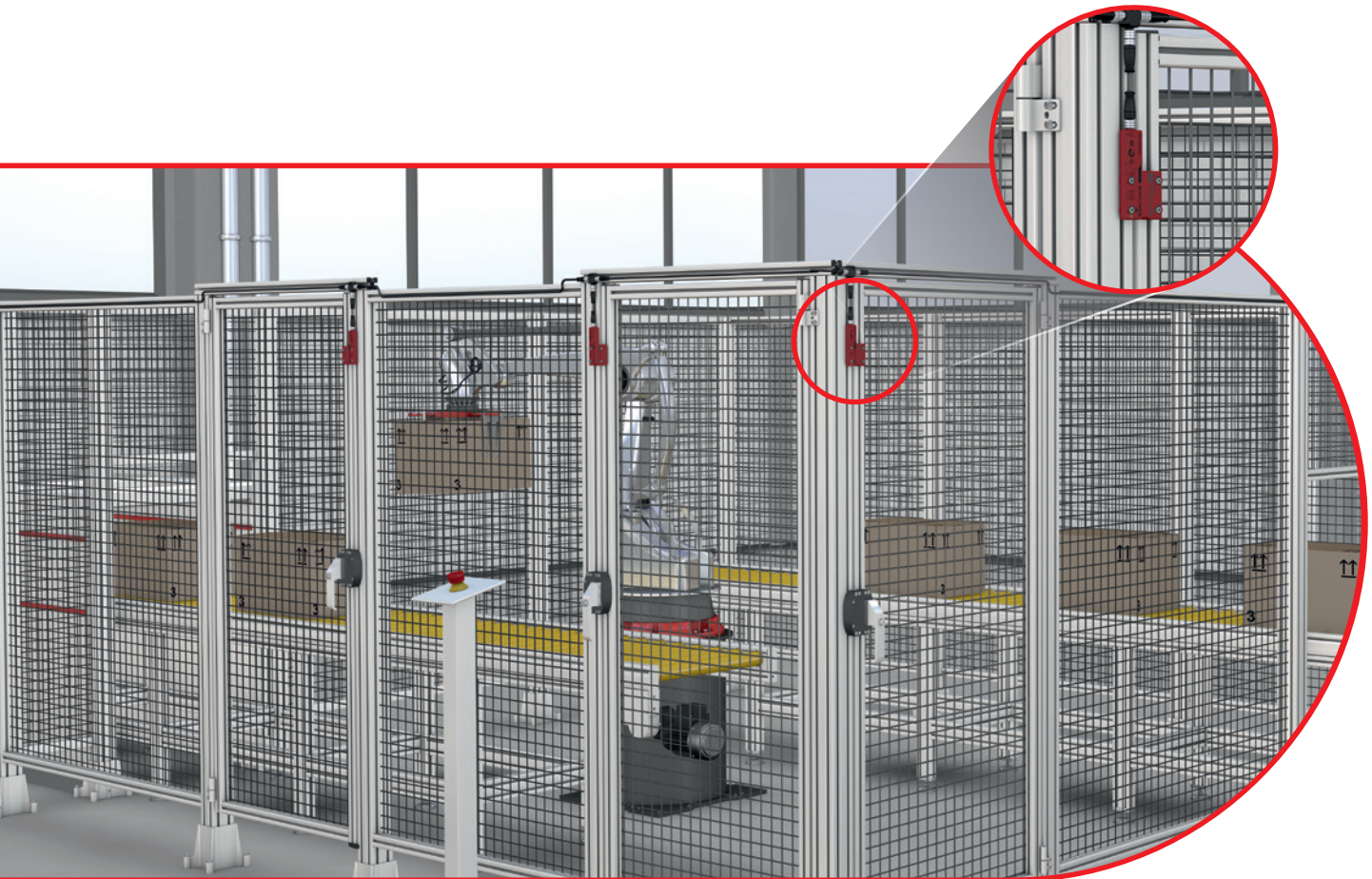

Moved or misaligned doors and hoods often lead to an unplanned machine shutdown. The integrated diagnostic device makes it quick and easy to pinpoint protective guards located in the transitional area. This means a controlled machine shutdown is possible and the protection device can be returned to its starting position, therefore avoiding an unwanted machine shutdown.

Due to the fully potted electronics, the CSMS is insensitive to contamination and easy to clean. The CSMS is used in situations where machines with dangerous movements have no “over run” capability.

CSMS product advantages



Just scan the QR code and experience the CSMS online on the BERNSTEIN YouTube channel.



(in preparation)

- **Safety series connection** with max. 32 CSMS up to **PL e / SIL 3 (category 4)**
- **Reduction in cost** – no additional external monitoring is needed
- **Flexible application** – a manual and automatic start is possible with the same CSMS
- **Guaranteed future** – the CSMS fulfils the requirement of **ISO 14119** (successor to EN 1088) regarding an individual coding (**high-level coding**)
- **Economic system installation** due to the **simple** and **fast installation** with M12 plug technology
- **Time saving** – laborious troubleshooting as a result of wiring errors is now a thing of the past
- **Time saving** – the system status is displayed on the **diagnosis interface**
- **Reduction in costs** – no door or hood guides are necessary

CSMS product overview

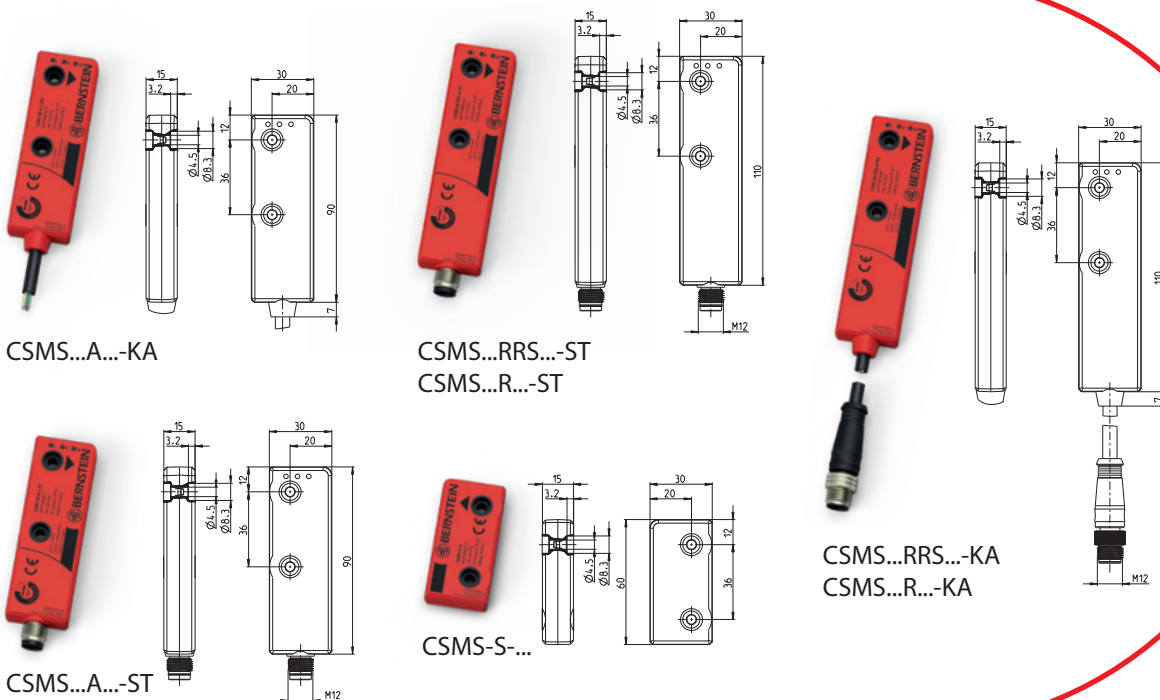

Technical data

- Rated operating voltage 24 V, polarity reversal protection
- Open-circuit current ≤ 55 mA
- Repeatability 0,1 x S (within the limits S_{min} and S_{max})
- Switching frequencies ≤ 1 Hz
- Switch-off delay time 13 ms + 200 μ s x following CSMS unit in serial connection (see page 10)
- **Readiness delay t_r**
- **CSMS...RRS with automatic start**
1,8 s + 33 ms x following CSMS unit
- **CSMS...RRS with Start button**
50 ms + 50 ms x following CSMS unit
- **CSMS...R**
320 ms + 50 ms x following CSMS unit
- Output current Safety contacts = 2x 250mA
- Enclosure Macromelt, red / PA 6, black
- Mounting through 2 holes $\varnothing 4,5$ (for M4 screws)
- Ambient temperature -25 °C to $+70$ °C
- Protection class IP 67
- Sensing distance S_n 13 mm

Further technical specifications can be obtained from the data sheet.

CSMS type and order codes

CSMS-SET-RRS-H-ST

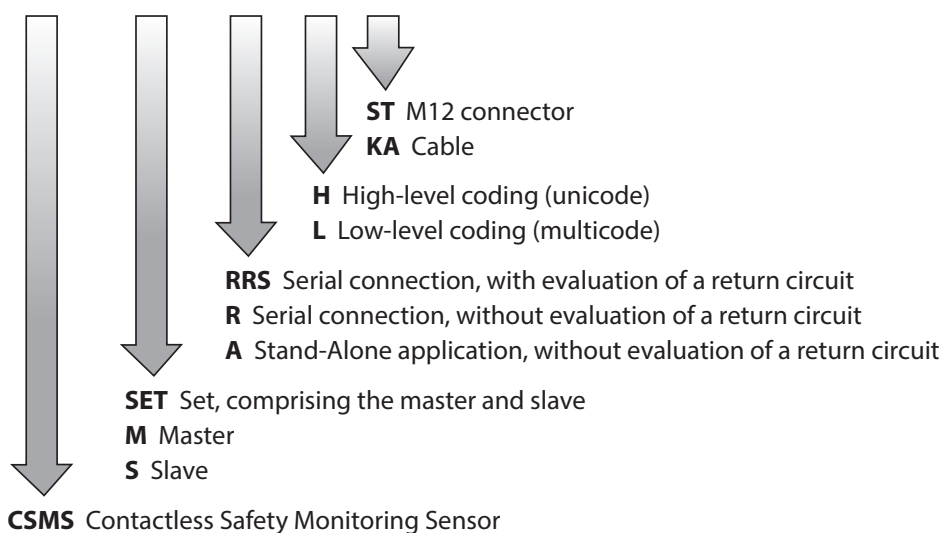

CSMS selection matrix

Serial connection	Evaluation of a return circuit	Unicode	Multicode	Diagnostic possibility	M12 connector	2 m cable + M12 connect.	Article number	Designation	Page
x	x	x		x		x	6075988057	CSMS-SET-RRS-H-KA	10
x	x	x		x	x		6075988058	CSMS-SET-RRS-H-ST	10
x	x		x	x	x		6075988066	CSMS-SET-RRS-L-ST	10
x	x		x	x		x	6075988068	CSMS-SET-RRS-L-KA	10
x		x		x		x	6075988059	CSMS-SET-R-H-KA	11
x		x		x	x		6075988060	CSMS-SET-R-H-ST	11
x			x	x	x		6075988067	CSMS-SET-R-L-ST	11
x			x	x		x	6075988069	CSMS-SET-R-L-KA	11
			x		x		6075988072	CSMS-SET-A-L-ST	12
			x			x**	6075988073	CSMS-SET-A-L-KA	12
		Replacement actuator Multicode					6075980065	CSMS-S-L	10-12
		Replacement actuator Unicode					6075980052	CSMS-S-H*	10-11

* Must be taught in with 6075989056 (CSMS SLAVE TEACHADAPTER) for the master.

** 2 m cable without M12 connector

Fast shutdown

Another characteristic of the CSMS is the fast shutdown of the safety outputs - the switch-off signal is generated as soon as the door opens, enabling an immediate shutdown of the dangerous movement. The safety-relevant switch off of each individual CSMS takes place after **13 ms**, of a safety chain with max. 32 participants after **20 ms**.

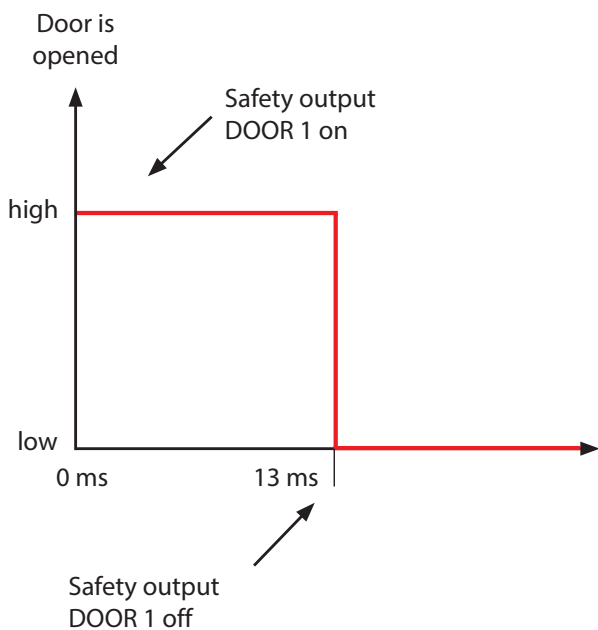

Advantages of fast shutdown:

Thanks to the fast shutdown, it is possible to significantly reduce the area of the dangerous movement which is to be protected. This results in savings in both protective guards and hoods, as well as in space.

Sensing distance

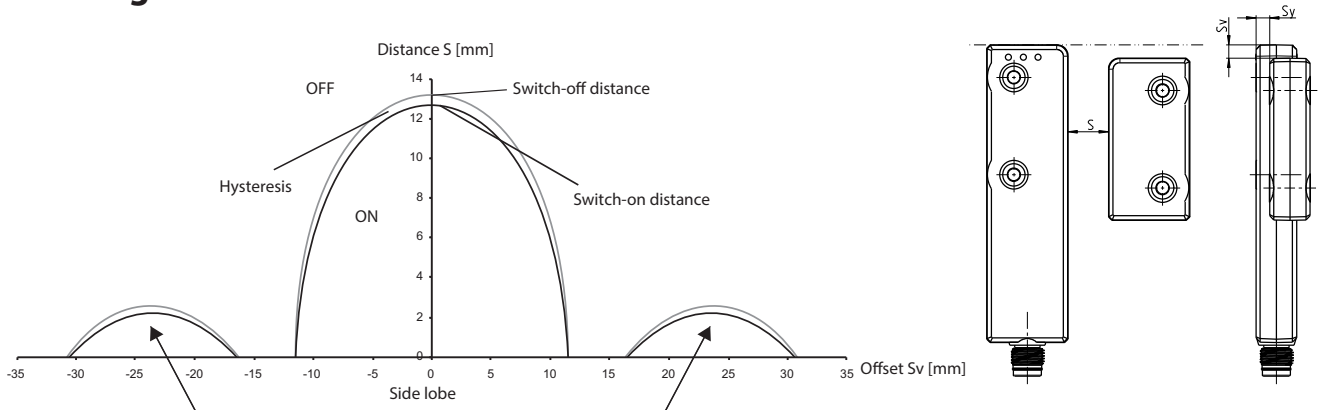

Please note:
Metal may also affect the sensing distance.

Rated sensing distance S_n	13 mm
Assured sensing distance – (On) S_{so}	min. 10 mm
Assured sensing distance – (Off) S_{sr}	19 mm
Hysteresis H	0,5 mm

CSMS-RRS

with evaluation of a return circuit
(without an external safety switching device)

Serial connection

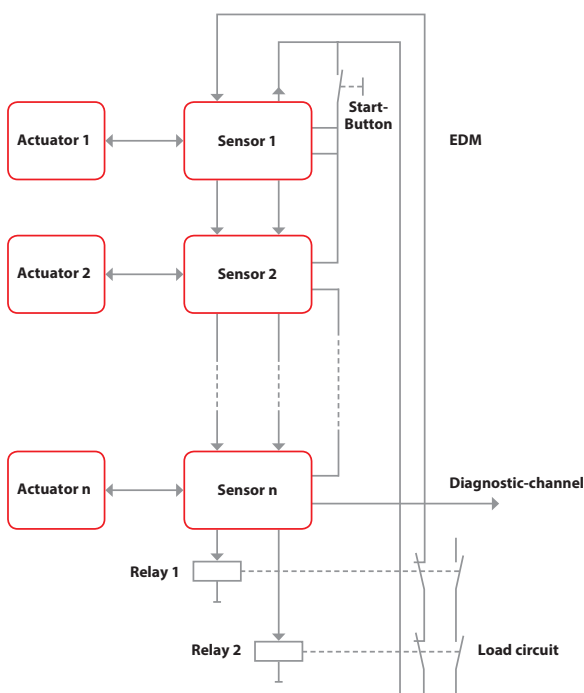

Individual application

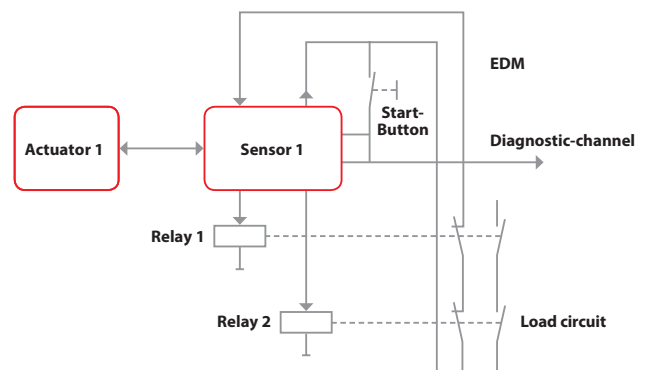

Advantages

- Individual CSMS or safe serial connection with max. 32 CSMS up to **PL e**
- Manual or automatic start
- No external safety evaluation unit required
- Uni- or multi-coding
- Integrated evaluation of a return circuit and start button with direct connection to contactors

Unicode	Multicode	M12 connector	2 m cable + M12 connector	Article number	Designation
x			x	6075988057	CSMS-SET-RRS-H-KA
x		x		6075988058	CSMS-SET-RRS-H-ST
	x	x		6075988066	CSMS-SET-RRS-L-ST
	x		x	6075988068	CSMS-SET-RRS-L-KA
x			x	6075985048	CSMS-M-RRS-H-KA
x		x		6075986050	CSMS-M-RRS-H-ST
	x		x	6075985061	CSMS-M-RRS-L-KA
	x	x		6075986062	CSMS-M-RRS-L-ST
	Replacement actuator Multicode			6075980065	CSMS-S-L
	Replacement actuator Unicode			6075980052	CSMS-S-H*

*Must be taught in with 6075989056 (CSMS SLAVE TEACHADAPTER) for the master.

CSMS-R

for the connection to a safety evaluation unit

Serial connection

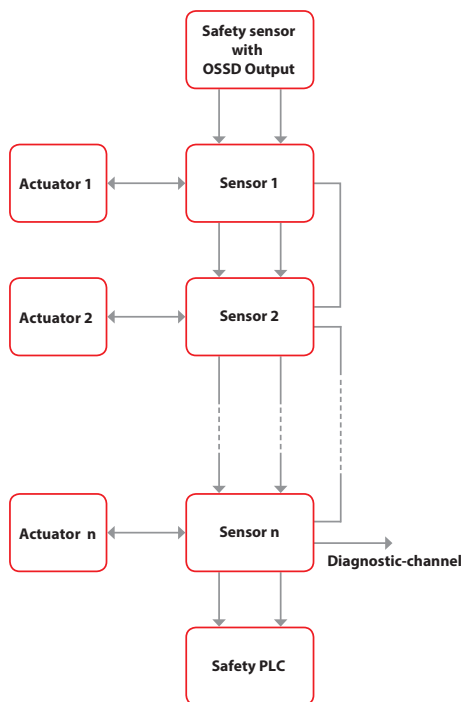

Individual application

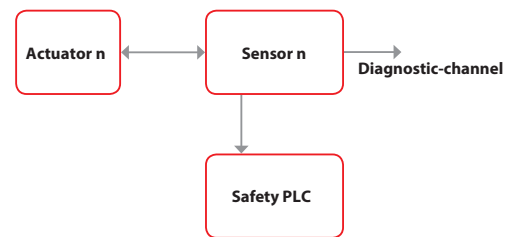

Advantages

- Safe serial connection with max. 32 CSMS up to **PL e**
- Connection to an external safety evaluation unit for ex. SCR ON (see page 19)
- Optional: Connection of a safety sensor (for ex. safety light curtain) with OSSD output to the first CSMS
- Uni- or multi-coding

Unicode	Multicode	M12 connector	2 m cable + M12 connector	Article number	Designation
x			x	6075988059	CSMS-SET-R-H-KA
x		x		6075988060	CSMS-SET-R-H-ST
	x	x		6075988067	CSMS-SET-R-L-ST
	x		x	6075988069	CSMS-SET-R-L-KA
x			x	6075985049	CSMS-M-R-H-KA
x		x		6075986051	CSMS-M-R-H-ST
	x		x	6075985063	CSMS-M-R-L-KA
	x	x		6075986064	CSMS-M-R-L-ST
	Replacement actuator Multicode			6075980065	CSMS-S-L
	Replacement actuator Unicode			6075980052	CSMS-S-H*

*Must be taught in with 6075989056 (CSMS SLAVE TEACHADAPTER) for the master.

CSMS-A

for direct connection to a control unit

Parallel connection

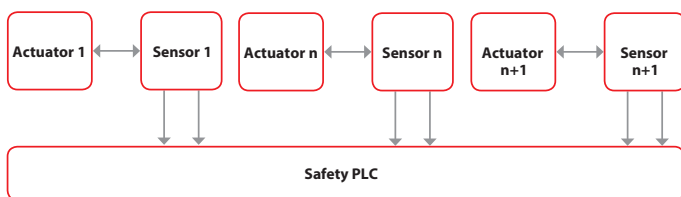

Individual application

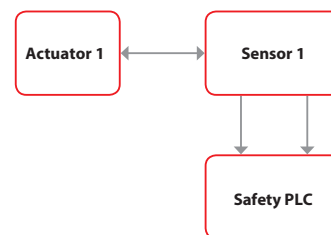

Advantages

- Up to **PL e / SIL 3**
- Multi-coding
- Compact construction
- Connection to an external safety evaluation unit for ex. SCR ON (see page 19)

Unicode	Multicode	M12 connector	2 m cable	Article number	Designation
	x	x		6075988072	CSMS-SET-A-L-ST
	x		x	6075988073	CSMS-SET-A-L-KA
	x		x	6075985070	CSMS-M-A-L-KA
	x	x		6075986071	CSMS-M-A-L-ST
	Replacement actuator Multicode			6075980065	CSMS-S-L

CSMS diagnosis

The CSMS product family offers one of the **largest diagnostic options** on the market. Opened protective devices or actuators in the transitional area as well as system failures can be rapidly and precisely identified. Due to the optional diagnostic devices, the status of each CSMS appears in the security chain.

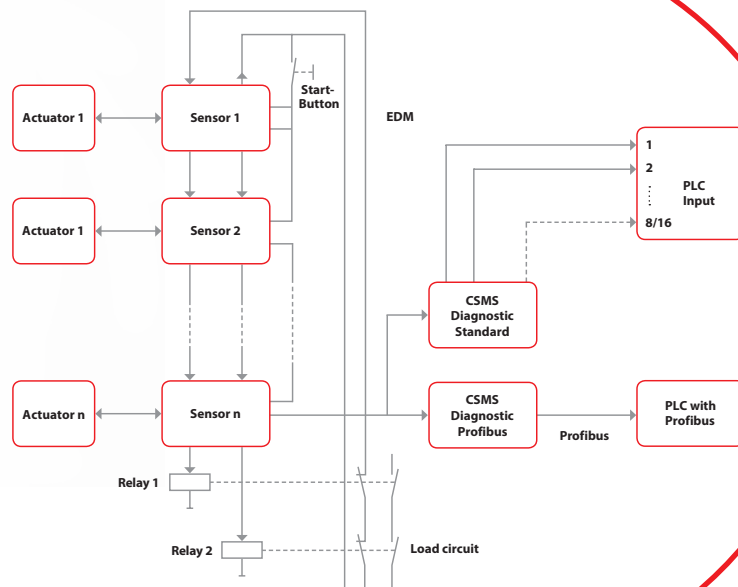

- Status display of each CSMS in the security chain
- Electronical outputs or bus interface

● CSMS Standard Diagnosis

The CSMS Standard Diagnosis has **8 or 16 electronic outputs**. Each output is assigned to one CSMS. It is possible to switch on the output, even at the maximum operating distance. The output is switched on by dip switches on the diagnostic device. In maximum system conception, the status of all 32 CSMS can be displayed simply by cascading the diagnostic devices.

● CSMS Diagnosis Profibus

The CSMS Diagnosis Profibus with Profibus interface ensures the direct transmission of the diagnostic informations of each CSMS to the control unit.

Advantages include considerably reduced wiring expenses, a clearer arrangement and a substantially higher functionality.

As well as protective devices in an open position or in the transitional area, attempts to tamper with the machine and system errors can also be detected.

The machine down time can be reduced to a minimum by the extensive diagnostic options.

Further bus systems on request.

Article number	Designation	Description
6075989031	CSMS DIAGNOSE STANDARD 8	Diagnosis for 8 CSMS
6075989032	CSMS DIAGNOSE STANDARD 16	Diagnosis for 16 CSMS
6075989033	CSMS DIAGNOSE PROFIBUS	Profibus Gateway

Simple wiring due to M12 plug technology and T-Adapter

By using M12 plug technology and T-Adapter, installation time and effort is reduced and correct wiring is guaranteed.



T-Adapters to be used

Versions	Start function	1. T-Adapter	Following T-Adapter
Version RRS	Manual start Automatic start	Grey Black	Black Black
Version R		Grey	Black

Accessories CSMS

Article number	Designation	Description	
6075989038	CON-CAB.CSMS 0,5M G/G	Length: 0,5 m	Connection cable M12 / 8-pin male / female
6075989039	CON-CAB.CSMS 1M G/G	Length: 1 m	
6075989040	CON-CAB.CSMS 2M G/G	Length: 2 m	
6075989041	CON-CAB.CSMS 5M G/G	Length: 5 m	
6075989042	CON-CAB.CSMS 10M G/G	Length: 10 m	
6075989043	CON-CAB.CSMS 20M G/G	Length: 20 m	
6075989053	CON-CAB.CSMS 0,3 M G	Length: 0,3 m	Connection cable M12 / 8-pin female / open
6075989054	CON-CAB.CSMS 2 M G	Length: 2 m	
6075989036	T-Adapter AS	T-Adapter (black) for series circuits (see the table above)	
6075989037	T-Adapter MS	T-Adapter (grey) for series circuits (see the table above)	
6073900070	SPACER short		
6075989044	SPACER long		
6075989031	CSMS DIAGNOSE STANDARD 8	Diagnosis for 8 CSMS, 8 PNP outputs	
6075989032	CSMS DIAGNOSE STANDARD 16	Diagnosis for 16 CSMS, 16 PNP outputs	
6075989033	CSMS DIAGNOSE PROFIBUS	Diagnosis for up to 32 CSMS with Profibus Gateway	
6075989055	CSMS BASIS CONNECT. DEVICE	Connection device for easy and fast installation of the CSMS system	
6075989056	CSMS SLAVE TEACHADAPTER	Tool for teaching in a replacement actuator	

Coded magnetic switch for safety functions

The safety magnetic controller processes the NC or NO contact signals coming from the coded magnetic switches. Therefore, it is possible to detect the opening of the safety guard (door, hatch, protective hood etc.) and to turn off the safety output.



BERNSTEIN offers magnetic controllers for safety functions that fulfill **performance level d** according to **ISO 13849-1** and **SIL 3** according to **IEC 62061**. The system consists of the following components:

- Magnetic controller for safety functions
- Corresponding coded transducer units

Depending on the type of device, one or two coded transducer units (magnetic switch with corresponding magnet) of type:

- MAK-4236
- MAK-5236
- MAK-5336

can be connected to and monitored by the safety magnetic controllers (see page 16).

Features

- Redundancy by NO and NC contacts
- Manipulation safety by multi-coding
- Monitoring of the return circuit (depending on device type)
- **PL d** according to **ISO 13849-1**
- **SIL 3** according to **IEC 62061**

Coded magnetic switch



MAK-4236

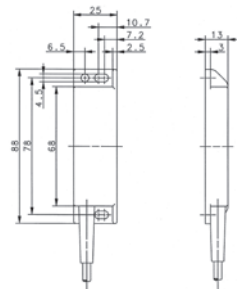

MAK-5236

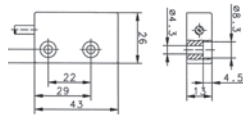

MAK-5336

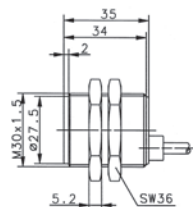

Features coded magnet switch in combination with a safety evaluation unit:

- Redundancy by NO and NC contacts
- Manipulation safety by multi-coding

Technical data

- Ambient temperature **-5 °C to +70 °C**
- Protection class **IP 67**
- Enclosure material **PA 6.6** (MAK 42 and 53) and **PBT** (MAK 52)

Article number	Designation	Cable length	Sensing distance S_{an}	Ref. magnet Designation	Ref. magnet Article number
6490642315	MAK-4236-3	3 m	4 mm	TK-42-CD	640204310
6490642302	MAK-4236-6	6 m			
6490642303	MAK-4236-9	9 m			
6490642305	MAK-4236-STK	Connector			
6490652316	MAK-5236-3	3 m	3 mm	TK-52-CD/2	6402052311
6490652307	MAK-5236-6	6 m			
6490652308	MAK-5236-9	9 m			
6490652309	MAK-5236-STK	Connector			
6490653317	MAK-5336-3	3 m	3 mm	TK-43-CD	6402043312
6490653311	MAK-5336-6	6 m			
6490653312	MAK-5336-9	9 m			
6490653313	MAK-5336-STK	Connector			

Safety evaluation unit for coded magnetic switch

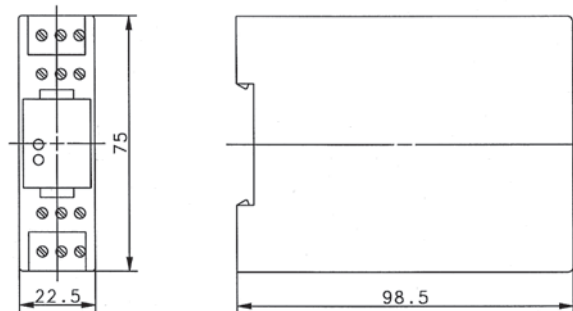

Technical data

- Operating voltage 24 V DC
- Switching voltage of the safety output 250 V AC
- Switching voltage of the safety output 8 A
- Ambient temperature **0 °C to +55 °C**
- Protection class IP 20
- Enclosure material PC

	MÜZ-102/D24-FL-DA	MÜZ-202/D24-FL
Article number	6392701306	6392702307
Connectable MAK	1	2
Return circuit	Yes	No
Data output (NC)	Yes	No

Dimensions

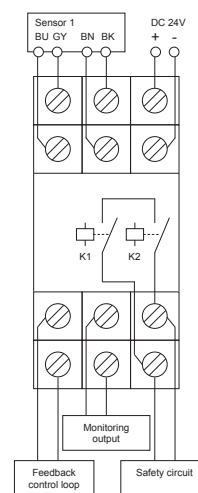

MÜZ-102

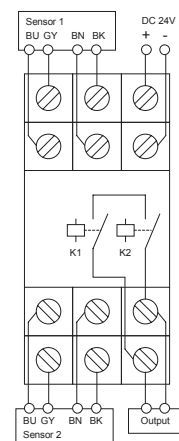

MÜZ-202

Safety basis monitor

The Safety Basis Monitor is a graphically programmable safe “miniature control unit”. Overall, the safe control unit supports a **maximum of 35 participants**.

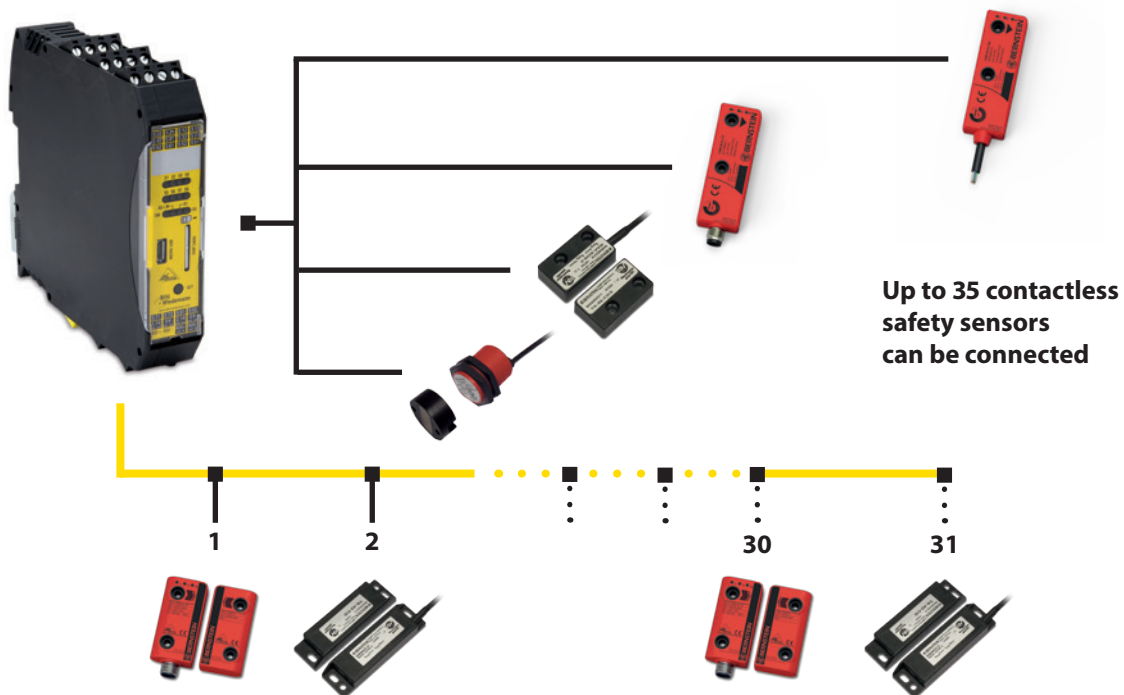

Features

- Evaluation of a return circuit
- Manual / automatic start
- Up to **PL e / SIL 3**
- Two safe electronic outputs
- Time delay for safe outputs
- Graphically programmable
- Connection of max. 4x2 bzw. 8x1 safety channels

Article number	Designation
6073100084	BASISMONITOR EXP. FUNCTION
6073800079	PROG. SOFTWARE
6073100078	USB-CA. F. ASI BASISMONITOR

SCR ON

For processing signals from the BERNSTEIN CSMS-R and CSMS-A, the safety relay series SCR ON can be used.

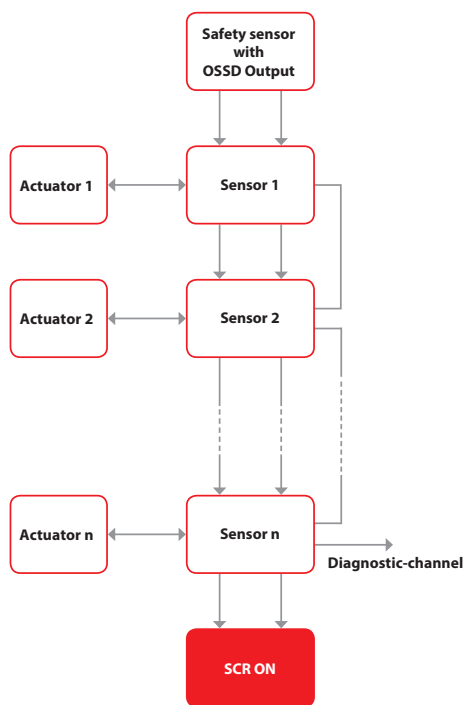

Features

- Monitoring of sensors with PNP output
- **PL e** according to **ISO 13849**
- Monitored start / automatic start
- Three enabling current paths (NO)
- Evaluation of a return circuit

For further information refer to the Complete Range of Switch Systems and Safety Technology brochure



Article number	Designation
6075111020	SCR ON4-W22-3.6-S



**Switch systems –
Economy meets safety**



**Sensor systems –
Compact intelligence**



**Enclosure systems –
Function and design**

www.bernstein.eu

Contact

**International Headquarters
BERNSTEIN AG**
Hans-Bernstein-Str. 1
32457 Porta Westfalica
Fon +49 571 793-0
Fax +49 571 793-555
info@de.bernstein.eu
www.bernstein.eu

**Denmark
BERNSTEIN A/S**
Fon +45 7020 0522
Fax +45 7020 0177
info@dk.bernstein.eu

**France
BERNSTEIN S.A.R.L.**
Fon +33 1 64 66 32 50
Fax +33 1 64 66 10 02
info@fr.bernstein.eu

**Italy
BERNSTEIN S.r.l.**
Fon +39 035 4549037
Fax +39 035 4549647
info@it.bernstein.eu

**United Kingdom
BERNSTEIN Ltd**
Fon +44 1922 744999
Fax +44 1922 457555
info@uk.bernstein.eu

**Austria
BERNSTEIN GmbH**
Fon +43 2256 62070-0
Fax +43 2256 62618
info@at.bernstein.eu

**Switzerland
BERNSTEIN (Schweiz) AG**
Fon +41 44 775 71-71
Fax +41 44 775 71-72
info@ch.bernstein.eu

**Hungary
BERNSTEIN Kft.**
Fon +36 1 4342295
Fax +36 1 4342299
info@hu.bernstein.eu

**China
BERNSTEIN Safe Solutions
(Taicang) Co., Ltd.**
Fon +86 512 81608180
Fax +86 512 81608181
info@bernstein-safesolutions.cn